

PUMPING GROUP WITH 7 PUMPS FOR WET PIPES AN/GAH7

Description

Pumping equipment composed of 7 volumetric type electric pumps with ceramic pistons, with a flow rate of 40L / min and a pressure of 140 bar, with a three-phase electric motor of 400 V and 15C.V (11.04 kw) each, plus one stainless steel centrifugal pump with a flow rate of 24 m³ / h and a power of 3 CV enough to supply all pumps. The supply pressure will be ensured by this overpressure pump at <4 bar. The equipment is completed with a jockey pump with a flow rate of 1 l / min regulated at a pressure between 35 and 40 bar, with an electric motor of 230 V and 0.747 CV. The electrical control panel that regulates the operation of the equipment is designed according to the UNE 23500 standard and allows remote alarms to be issued. The equipment is made up of a pump controlled by a frequency inverter and the others by soft starters. It is delivered mounted on a universal bench, regulated according to the working pressure according to the project and its operation checked.

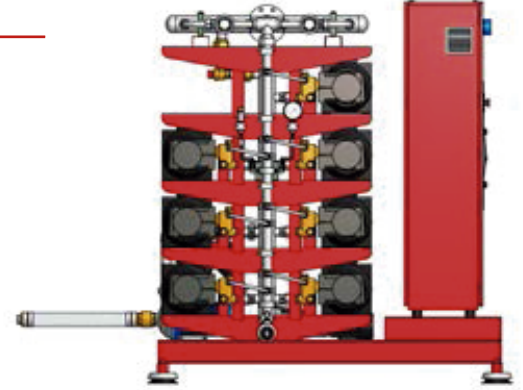

Equipment

The pumping equipment is delivered with:

- High pressure flexible hose for delivery, 1 ½ "and 600mm in length. Swivel female connection BSP 11/2 "thread.
- Low pressure suction hose, 2 "and 600mm long. 2 "BSP male thread connection.
- 3 "return manifold with DIN 2632/33 connection flange.

Dimensions

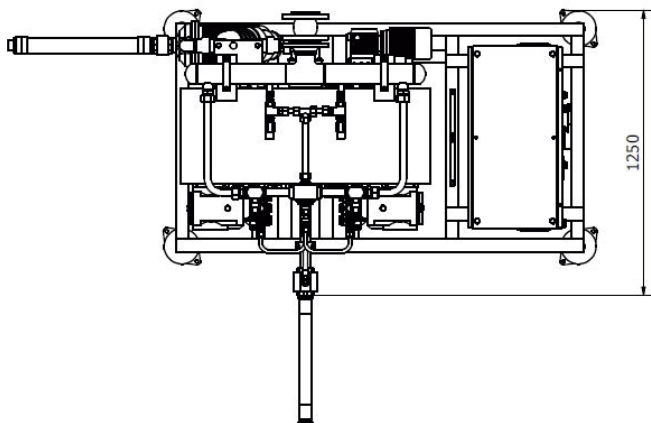
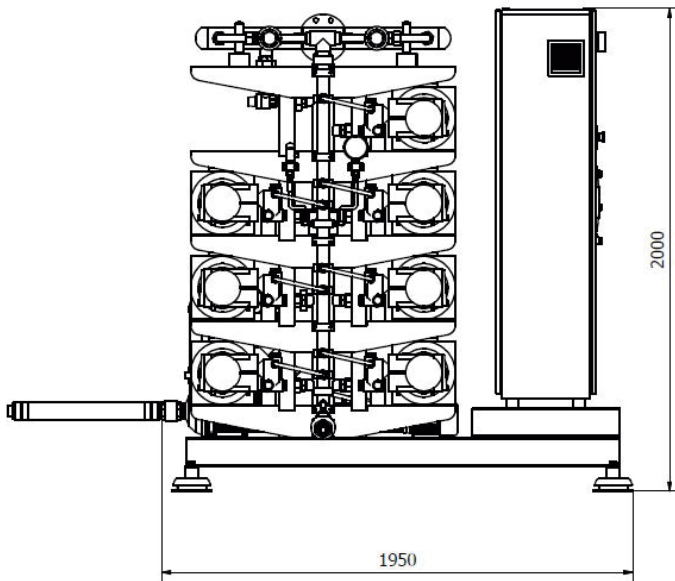

Consumption

Group total power: 81.04 Kw

Elements

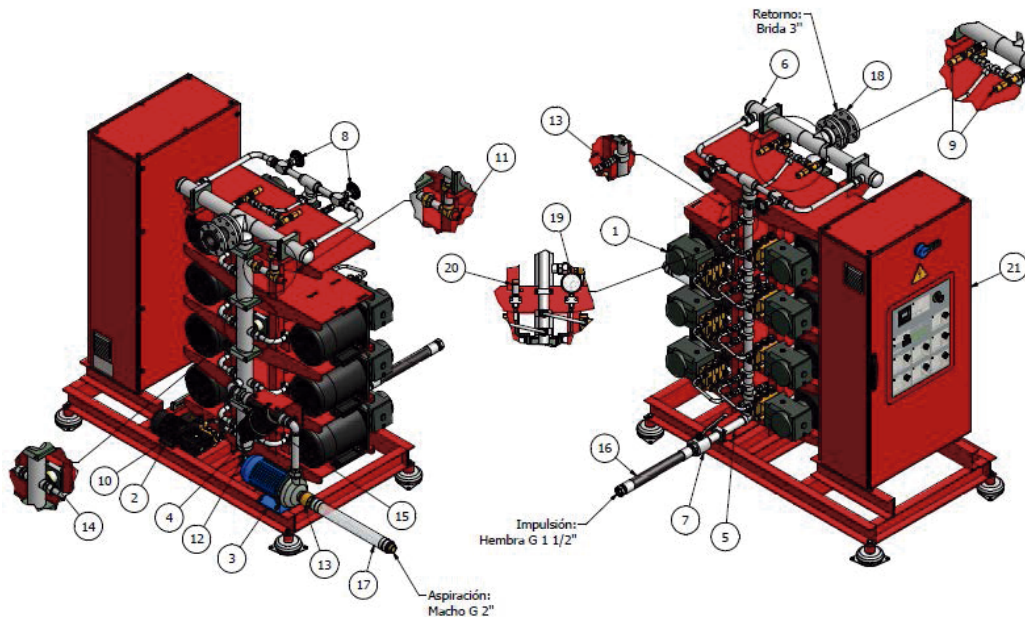

1. Main Pump: It supplies the necessary flow to cover the demand of the risk at the working pressure.
2. Jockey Pump: Maintains a pressure of 40 Bar (pressurization) in wet and mixed installations.
3. Overpressure pump: It feeds the suction manifold to guarantee the flow rate and prevent any pump from working in vacuum.
4. Suction manifold: Manifold where all the pumps are fed except the overpressure one.
5. Impulse collector: Collector located downstream of the main pumps through which the entire installation is fed.
6. Return collector: Collector through which the excess water returns to the tank.
7. Drive valve: Valve connected to the drive manifold through which the entire installation is fed.
8. Test valve: Valve for performing functional tests on the equipment with water return to the tank.
9. Main regulating valve: Prevents overpressure in the discharge manifold. The water relief is discharged into the return manifold. Depending on the configuration of the equipment, it can incorporate 2 units.
10. Auxiliary regulation valve: Regulates the Jockey pump, responsible for relieving excess water by returning it to the suction manifold.
11. Relief valve: Relieves pressure in the suction manifold.
12. Drain valve: Drain or bleed valve of the suction manifold.
13. Non-return valves: Installed one per main pump and Jockey pump. One is also supplied to install it in the suction inlet, pump or manifold.
14. Pulsation Damper (Impulse Manifold): Stabilizes the pressure transducer reading.

15. Filters: It incorporates a general one for all the pumps except the overpressure pump.
16. Impulse hose: Flexible hose that connects the outlet of the impulse valve with the outlet pipe to the installation, in order to minimize the transmission of vibrations from the equipment.
17. Suction hose: Flexible hose that connects the intake pipe (tank outlet) with the inlet check valve of the overpressure pump (equipment > 3 pumps) or with the anti-return valve of the suction manifold (equipment < 3 Pumps), in order to minimize the transmission of vibrations from the equipment.
18. Flange with anti-vibration and return hose: The flange connects the return manifold with the return pipe to the tank (equipment > 3 pumps) and with a return hose to connect the outlet of the test valve and the regulation valve. with the return pipe to the tank (equipment < 3 pumps), in order to minimize the transmission of vibrations from the equipment.
19. Pressure gauge: Indicates the pressure in the discharge manifold.
20. Pressure transducer: Indicates the pressure in the discharge manifold by means of a 4-digit display. Generates a 4-20 mA analog signal. Depending on the pressure in the discharge manifold, it also activates a digital signal (led SP1) when the pressure exceeds 160 Bar. If the equipment is not connected, an emergency stop of the pressure group occurs.
21. Command and control panel: Panel of the electrical panel from which the pump group is operated.